



Experimental characterization of ceramic pebble beds

N. Zaccari*, D. Aquaro

Dipartimento di Ingegneria Meccanica Nucleare e della Produzione, University of Pisa, Italy

A B S T R A C T

Several materials have been developed in Europe and Japan for the DEMO reactor that will be tested in ITER. The paper describes a solid breeder for nuclear fusion reactor exploiting ceramic pebbles made of Lithium Orthosilicate (Li_4SiO_4) and Lithium metatitanate (Li_2TiO_3), with a diameter ranging between 0.5 mm and 1 mm. The main advantages of the pebbles are resistance to thermal stresses and the possibility to easily fill the complex geometries of the blanket. The results of experimental tests are presented, which enable the determination of the behaviour of single pebbles under compression and the parameters of the pebble beds needed to define their constitutive equations. Several standard tests on samples of pebble beds were performed: triaxial, direct shear and compression. The parameters of the Cam–Clay model were obtained from these tests. This model is normally used to describe soil materials (clay, sand) but in our case was used to simulate the triaxial tests with a finite elements computer code. The numerical results show a good agreement with the theoretical ones. Therefore this model could be used to determine the mechanical behaviour of the solid breeding blanket under normal and accidental conditions.

© 2009 Published by Elsevier B.V.

1. Introduction

Several authors [1,2] have experimentally analyzed pebble beds by means of uniaxial compression tests (oedometer tests). With this test a displacement–load curve can be obtained under lateral constraints, but there is no data on the shear resistance of the pebble bed or on its three-dimensional behaviour. Moreover, there is very little data on the mechanical behaviour of a single pebble under compression until rupture. The aim of this work was to obtain experimental data on the pebbles and on the pebble beds in order to define a model that could be used in an FEM code. The paper shows in the first part the results of the compression of single pebbles [3] of Li_4SiO_4 and of Li_2TiO_3 . Subsequently the results of direct shear tests on Li_4SiO_4 pebble beds and of triaxial tests on Li_4SiO_4 and Li_2TiO_3 pebble beds are illustrated. The elaboration of the previous results are elaborated in order to determine the parameters of the Cam–Clay and to simulate the triaxial tests with an FEM code.

2. Experimental test on pebbles of lithium orthosilicate and metatitanate

Compression tests were performed at room temperature on lithium orthosilicate (Li_4SiO_4) pebbles (diameter 0.5–0.6 mm) and Li_2TiO_3 pebbles, (diameter 1.2–1 mm) [3]. The pebbles were pro-

duced by FZK-Schott and CEA [5,6]. The pebbles were analyzed by SEM before the test in order to estimate the average diameter and to normalize the results to a nominal diameter equal to 0.56 mm for Li_4SiO_4 and 1.16 mm for Li_2TiO_3 .

Fig. 1 shows the best-fit curves of the load (P) versus displacement (s) obtained during the loading and unloading phases of the tested pebbles. Some pebbles were subjected to several loading cycles without reaching failure, others were compressed until collapse.

The regression curves calculated with the least square method are expressed by the following equations:

- (a) Lithium orthosilicate
- Loading phase: $P = 3613 s^{1.903} \quad r^2 = 0.92$.
 - Unloading phase: $P = 7657 s^{1.892} \quad r^2 = 0.974$.
- (b) Lithium metatitanate
- Loading phase: $P = 687.55 s^{1.257} \quad r^2 = 0.9917$.
 - Unloading phase: $P = -3.287 + 733.62 s \quad r^2 = 0.9854$.

The previous relations can be expressed in terms of mean stress versus mean strain thus transforming the pebbles into an effective cylinder of average radius \bar{r} , and $2\bar{r}$ of height (for Li_4SiO_4 pebbles of radius, $\bar{r} = 0.28$ mm and for Li_2TiO_3 pebbles of $\bar{r} = 0.58$ mm).

– For Li_4SiO_4 :

– loading phase :

$$\sigma = \frac{P}{\pi \cdot \bar{r}^2} = \frac{3613}{\pi \cdot \bar{r}^2} \cdot (2\bar{r})^{1.903} \cdot \left(\frac{s}{2\bar{r}}\right)^{1.903} \Rightarrow \sigma = 4866.4 \cdot \varepsilon^{1.903} \quad (1)$$

* Corresponding author.

E-mail address: nicola.zaccari@enel.it (N. Zaccari).

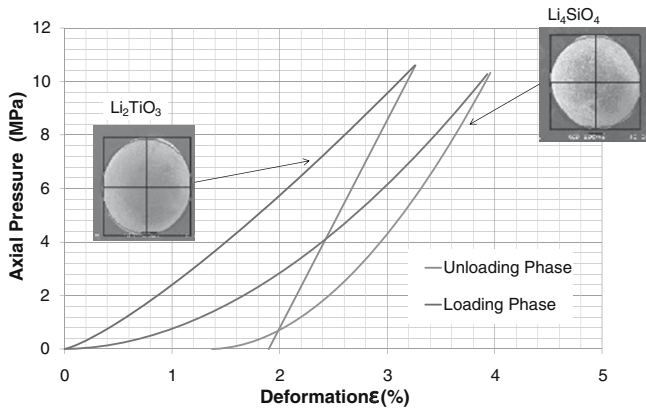

Fig. 1. Loading and Unloading phase of tested pebbles.

– unloading phase :

$$\sigma = \frac{P}{\pi \cdot \bar{r}^2} = \frac{7657}{\pi \cdot \bar{r}^2} \cdot (2\bar{r})^{1.892} \cdot \left(\frac{s}{2\bar{r}}\right)^{1.892} \Rightarrow \sigma = 10379 \cdot \varepsilon^{1.892} \quad (2)$$

– For Li_2TiO_3 :

$$\text{– loading phase : } \sigma = \frac{P}{\pi \cdot \bar{r}^2} = \frac{687}{\pi \cdot \bar{r}^2} \cdot (2\bar{r})^{1.257} \cdot \left(\frac{s}{2\bar{r}}\right)^{1.257} \Rightarrow \sigma = 783.4 \cdot \varepsilon^{1.257} \quad (3)$$

$$\text{– unloading phase : } \sigma = \frac{P}{\pi \cdot \bar{r}^2} = -\frac{3.287}{\pi \cdot \bar{r}^2} + \frac{733.62}{\pi \cdot \bar{r}^2} \cdot (2\bar{r}) \cdot \left(\frac{s}{2\bar{r}}\right) \Rightarrow \sigma = -3.11 + 805.2 \cdot \varepsilon \quad (4)$$

The elastic part of the deformation (Hertzian contact) can be neglected with respect with the plastic part produced by the great contact stresses. Therefore Eq. (1) can be considered as an effective yielding stress–strain curve of the pebble material.

3. Direct shear tests on lithium orthosilicate pebble beds

The direct shear test is one of the oldest tests for characterizing soil [4]. Fig. 2 shows a direct shear device, which was used to determine the shear strength of a Li_4SiO_4 pebble bed and the angle of internal friction (ϕ). This test consists in measuring the shear force and the relative horizontal displacement between the two parts of the device. The test phases are as follows:

- The granular material is put into a cylindrical volume, made up of two metallic cylinders which can have a relative radial movement.

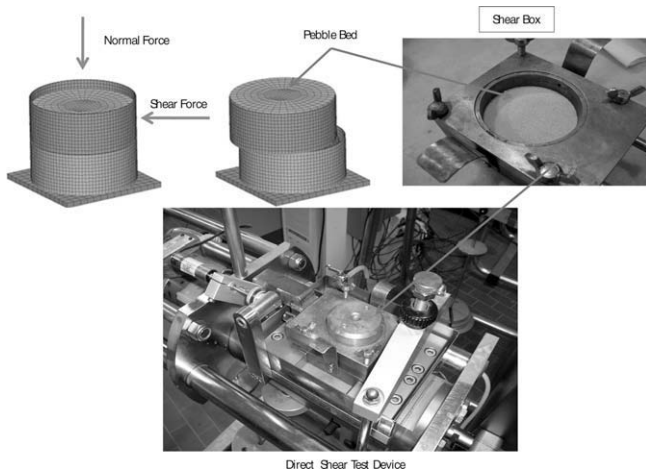

Fig. 2. Direct shear test apparatus.

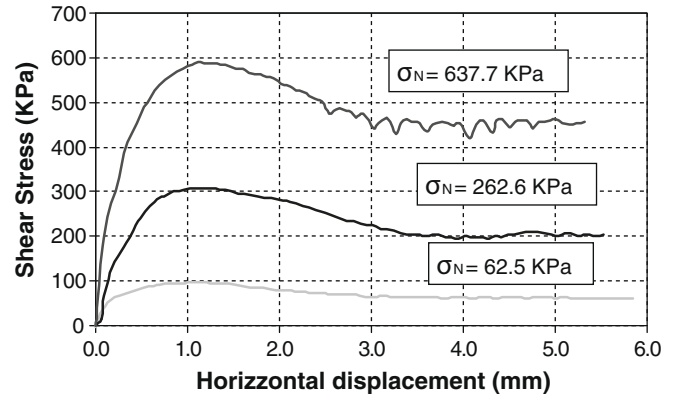

Fig. 3. Shear stress versus Horizontal Displacements of Li_4SiO_4 pebble bed.

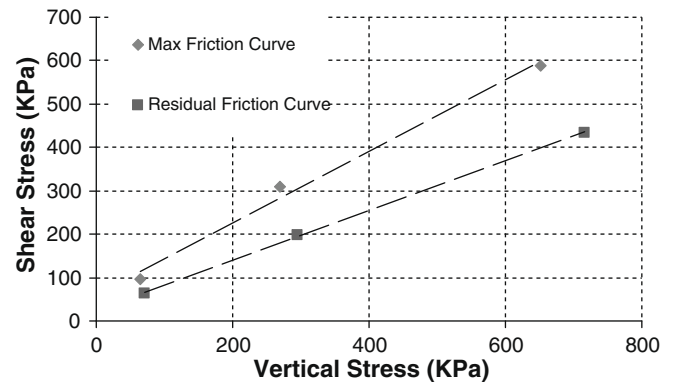

Fig. 4. Shear Curves of Li_4SiO_4 pebble bed.

- A constant normal stress is applied to the specimen.
- A horizontal force is applied to one cylinder at a constant rate which is then used to measure the corresponding displacement.

The cylindrical volume was 63.5 mm in diameter and 20 mm in height. The test was performed at room temperature on Li_4SiO_4 pebble beds, with a packing factor equal to $\gamma = 0.6$. Fig. 3 shows the shear stresses versus the horizontal displacement for three different values of normal stress (62.5 kPa, 262.6 kPa, 637.7 kPa).

The curves in Fig. 3 permit the parameters of the Mohr–Coulomb failure criterion to be obtained. This criterion is expressed by the following equation:

$$\tau = c + \tan(\phi)\sigma \quad (5)$$

where ϕ is the friction angle, c the cohesion, τ , the shear stress and σ the normal stress. Fig. 4 reports the maximum shear values reached in the test versus the corresponding normal stress. These experimental points can be used to determine the maximum friction angle (ϕ_{max}), from Eq. (5) (assuming that the cohesion is negligible). Similarly, the residual shear values (the constant values in Fig. 3) versus the corresponding normal stress, give the residual friction angle (ϕ_{res}). Fig. 4 shows the Mohr–Coulomb curves of the Li_4SiO_4 pebble beds, from which we obtain $\phi_{\text{max}} = 39.5^\circ$ and $\phi_{\text{res}} = 31.9^\circ$. The residual friction angle can also be obtained with the triaxial test as shown in the following section.

4. Tri-axial test on lithium orthosilicate and lithium metatitanate pebble beds

A three-axial compression test is used to determine the shear strength and the three-dimensional behaviour of a sample of soil

under controlled confining pressure at room temperature. In this test, a cylindrical specimen of soil encased in a rubber membrane, is placed in a compression chamber, subjected to a lateral fluid pressure and axially loaded until the failure. The test is called “three-axial” because the three principal stresses are assumed to

be known and controlled [7]. Initially the stress tensor of the sample is hydrostatic and the three principal stresses are equal to the chamber fluid pressure. Subsequently, one principal stress, σ_1 is equal to the axial stress (P/A , where P is the axial load, and A is the sample cross section area) and the other two principal stresses,

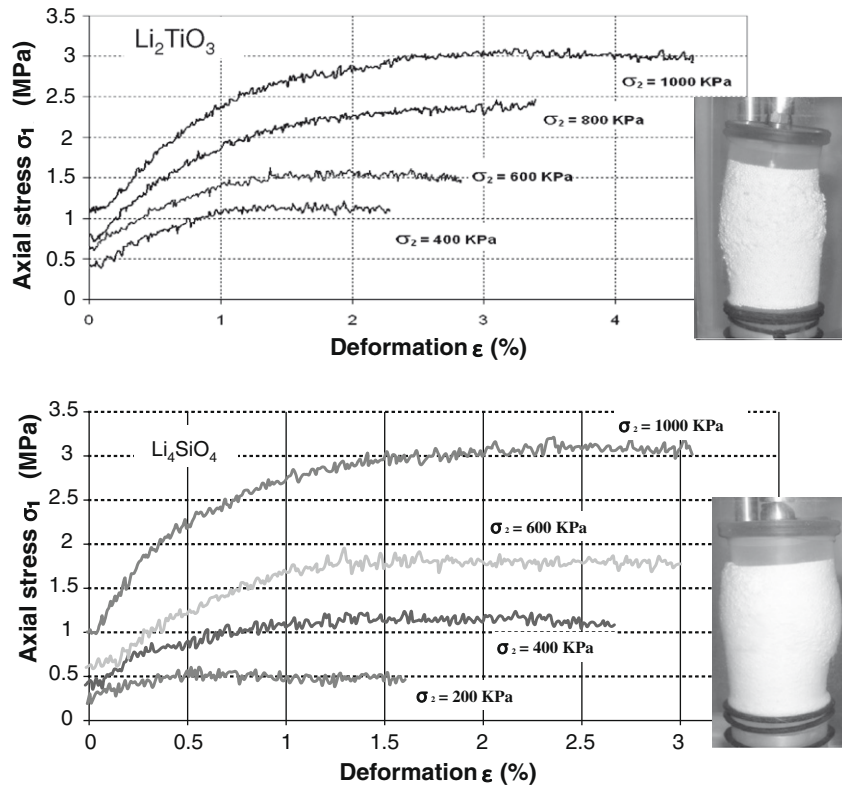

Fig. 5. Comparison of triaxial test results of pebble beds.

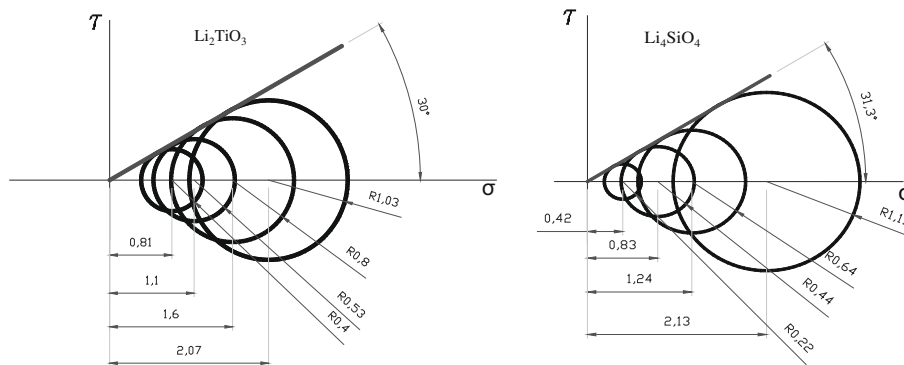

Fig. 6. Mohr's circles of pebble bed tested.

Table 1
Value for the construction of the Mohr's Circle.

Confining pressure (kPa)	Radius ρ (MPa)	Center C (MPa)	σ (MPa)	τ (MPa)	Confining pressure (kPa)	Radius ρ (MPa)	Center C (MPa)	σ (MPa)	τ (MPa)
400	0.4	(0.81; 0.0)	0.67	0.4	200	0.22	(0.42; 0.0)	0.35	0.22
600	0.53	(1.1; 0.0)	0.95	0.53	400	0.44	(0.83; 0.0)	0.69	0.435
800	0.8	(1.6; 0.0)	1.33	0.8	600	0.64	(1.24; 0.0)	1.03	0.64
1000	1.03	(2.07; 0.0)	1.72	1.03	1000	1.11	(2.13; 0.0)	1.75	1.11

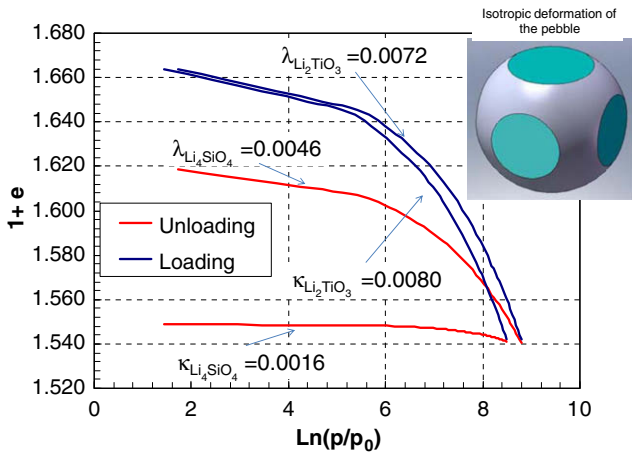

Fig. 7. Determination of λ , κ parameters.

Table 2
Cam-Clay parameters used for pebble beds tested.

Pebble's materials	M	κ	λ
Li_4SiO_4	1.23	0.0046	0.0072
Li_2TiO_3	1.15	0.0016	0.0079

σ_2 and σ_3 are equal to the chamber pressure. The stress difference, $q = \sigma_1 - \sigma_3$, is the “deviatoric stress” and is equal to twice the maximum shear stress.

The specimen used in our tests had a radius of 19 mm and was 76 mm in height. The packing factor (γ) of the tested beds was 0.60 while the confining pressures were 200, 400, 600, 800 and 1000 kPa.

Fig. 5 shows the axial stress σ_1 versus the strain ϵ (%) obtained in the tests on Li_2TiO_3 and Li_4SiO_4 pebble beds, respectively. The capability of the bed to sustain the load increases with the confining pressure. Fig. 6 shows the Mohr circles corresponding to the maximum stress state shown in Fig. 5, for the two materials examined. Table 1 reports the values used for the construction of the Mohr circles:

- The circle radius $\rho = (\sigma_1 - \sigma_2)/2$.
- The center coordinates (C) of Mohr’s circles, $C \equiv ((\sigma_1 + \sigma_2)/2; 0)$.
- The maximum shear stress (τ) $\tau = (\sigma_1 - \sigma_2)/2$.
- The hydrostatic stress (p). $p = (\sigma_1 + 2 \cdot \sigma_2)/3$.

These data were used to determine the Mohr–Coulomb failure curves (Eq. (5)) as the common tangent to the different Mohr circles. The slope of this curve is the friction angle of the pebble bed. The values obtained from Fig. 6 were 31.3° for Lithium Orthosilicate, and 30° for Lithium Metatitanate.

5. Parameters of the Cam–Clay model

Some authors [9,10] have simulated the pebble bed behaviour by means of FEM codes using models developed for soil, such as clay and sand. This section describes a method for determining the parameters of the Cam–Clay model by elaborating the test results on the pebbles and on the pebble beds.

The Cam–Clay model is used for simulating soil behaviour [8] and is implemented in several commercial FEM codes. It is an elastic plastic model characterized by a conical yielding surface, which is closed along the hydrostatic axis by an elliptical cap defined by the following equation:

$$F = 0 = \left(\frac{q}{M}\right)^2 - pp_c + p^2 \tag{6}$$

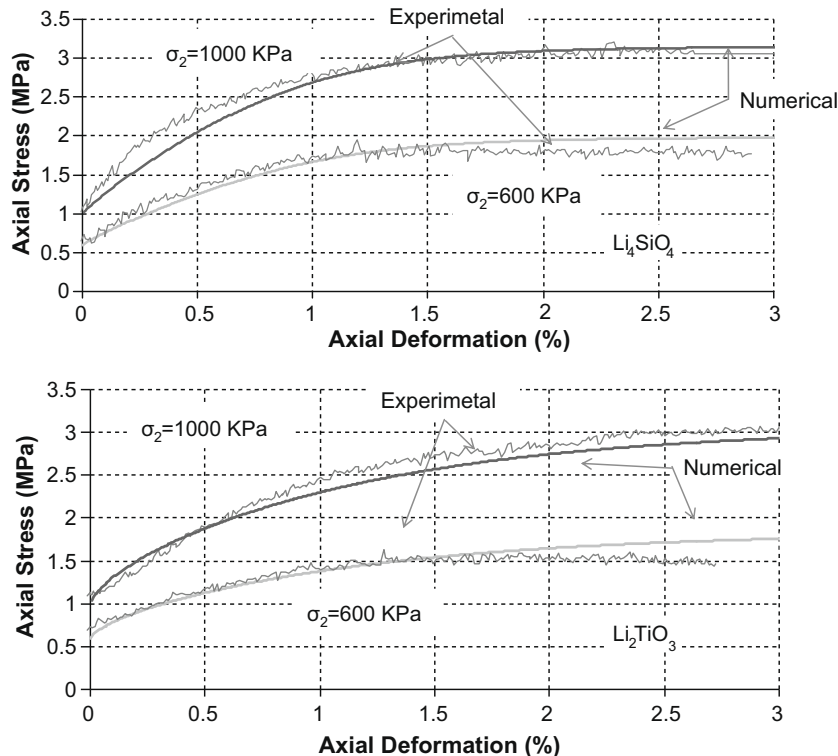

Fig. 8. Comparison between the numerical and experimental results of the triaxial tests.

where M is the slope of the cone generatrix (M is function the internal friction coefficient) and p_c is the pre-consolidation pressure. The associated flow rules are:

$$\text{in the loading } e_c - e_{c0} = \lambda \cdot \ln \left(\frac{p_c}{p_{c0}} \right)$$

$$\text{in the unloading } e - e_p = \kappa \cdot \ln \left(\frac{p}{p_0} \right)$$

where

- e_p , e_c , e_{c0} are the void ratio at the end of the unloading (corresponding to the initial pressure p_0), at the maximum pressure p_c , at the beginning of the plastic phase (corresponding to the pressure p_{c0}), respectively.
- λ and k are material constants. λ produces a hardening effect while k a swelling.

The main parameters of the model are thus M , p_c , λ and k , where

$$M = \frac{6 \sin \phi}{3 - \sin \phi},$$

and p_c is the maximum allowable hydrostatic pressure without hardening. Normally λ and k should be derived using isotropic compression tests, which measure the change in the sample volume in the loading and unloading phases. This test is difficult to carry out with ceramic breeder materials because they are hygroscopic. In fact, in the isotropic compression test, the sample is immersed in water and the volume change is determined by measuring the quantity of water that comes out from the sample during the test. λ and k can be derived from the Eqs. (1) and (2) for the Li_4SiO_4 and from Eqs. (3) and (4) for the Li_2TiO_3 . This is done on the assumption that the deformation of the pebble in one direction is not influenced by deformations that occur in the other directions, for loads that are much smaller than the crushing load. Fig. 7 illustrates the curves of the void ratio versus the logarithm of pressure for the two materials taken into consideration. The triaxial tests

were simulated with the FEM code MSC-MARC [11] using the Cam-Clay model with the parameters reported in Table 2. Fig. 8 compares the experimental and numerical results for the two ceramic pebble beds.

6. Conclusions

This paper illustrates some experimental tests that are normally used for characterizing soil, but which were used to evaluate the mechanical properties of lithium orthosilicate and lithium metatitanate pebble beds. These materials could be used as breeders in breeding blankets of nuclear fusion reactors. The experimental results enabled the determination of the parameters of the Cam-Clay model, which is generally used to simulate the soil behaviour with FEM codes. The triaxial tests produced results that were in good agreement with the experimental ones. We plan to develop the model to simulate phenomena that do not occur in soil (such as thermal creep) but are very important in the breeding blanket.

References

- [1] J. Reimann, L. Boccaccini, M. Enoeda, A.Y. Ying, Fus. Eng. Design 61–62 (November) (2002) 319.
- [2] J. Reimann, E. Arbogast, M. Behnke, S. Müller, K. Thomauske, Fus. Eng. Design 49–50 (November) (2000) 643.
- [3] D. Aquaro, N. Zaccari, Experimental and theoretical characterization of Li_2TiO_3 and Li_4SiO_4 pebbles", CBBI-14, Petten, The Netherlands, 6–8 September, 2006.
- [4] John H. Atkinson, Geotecnica:meccanica Delle Terre e Fondazioni, McGraw-Hill, 1997.
- [5] P. Gierszewski, Fus. Eng. Design 39–40 (1998) 739.
- [6] G. Schumacher et al., J. Nucl. Mater. 155–157 (1998) 451.
- [7] Alan W. Bishop, The measurement of soil properties in the three-axial test, London: Edward Arnold, 1957.
- [8] K.H. Roscoe, J.B. Burland, On the generalized stress-strain behavior of wet clay, engineering plasticity, Cambridge University Press, Cambridge, 1968. pp. 535–609.
- [9] D. Aquaro, N. Zaccari, Constitutive equations of Li_2TiO_3 and Li_4SiO_4 pebble beds obtained by means of standard triaxial tests: Implementation in a FEM code", ISFTN-8, 1–5 October 2007, Heidelberg, Germany.
- [10] Yixiang Gan, Marc Kamlah, Fus. Eng. Design 82 (2) (2007) 189.
- [11] MSC-MARC – Vol. A – Theory and User information' 2003 MSC. Software Corporation.